

Power supply

DPS series

INSTRUCTION MANUAL

Thank you for purchasing HANYOUNG product.
Please check whether the product is the exactly same as you ordered.
Before using the product, please read this instruction manual carefully.
Please keep this manual where you can view at any time

HEAD OFFICE

HANYOUNGNUX CO.,LTD

28, Gilpa-ro 71beon-gil, Nam-gu, Incheon, Korea
TEL : (82-32)876-4697 FAX : (82-32)876-4696 <http://www.hynux.com>

INDONESIA
FACTORY

PT. HANYOUNG ELECTRONIC INDONESIA

JL.CEMPAKA BLOK F 16 NO.02 DELTA SILICON II INDUSTRIAL PARK LIPPO CIKARANG
CICAU, CIKARANG PUSAT, BEKASI INDONESIA 17550 TEL : 62-21-8911-8120~4 FAX : 62-21-8911-8126



Safety information

Before using the product, please read the safety information thoroughly and use it properly. Alerts declared in the manual are classified to Danger, Warning and Caution by their criticality

	DANGER	DANGER indicates an imminently hazardous situation which, if not avoided, will result in death or serious injury
	WARNING	WARNING indicates a potentially hazardous situation which, if not avoided, could result in death or serious injury
	CAUTION	CAUTION indicates a potentially hazardous situation which, if not avoided, may result in minor or moderate injury

Danger

Do not touch or contact the input terminals because they cause electric shock.

Warning

- The contents of this manual may be changed without prior notification.
- Please install an appropriate protective circuit on the outside if malfunction or an incorrect operation may be a cause of leading to a serious accident.
- This product doesn't have power switch so it should be installed separately outside.
- Prior to using this product, accordingly the capacity of required purpose should be considered.
- To prevent electric shock or malfunction of product, do not supply the power until the wiring is completed.
- Please do not disassemble, manufacture, reform and repair this equipment. It leads to abnormality of movement, electric shock, and fire.
- Do not use this product which required flammable and explosive gas in an area.
- To prevent electric shock or malfunction of product, do not supply the power until the wiring is completed.
- Please turn off the power when mounting / dismantling of the product. This is a cause of electric shock, malfunction, or failure.
- To prevent deflection or malfunction of this product, supply proper power voltage in accordance with the rating.
- Please use this product after installing in the panel to prevent electrical shock.

Caution

- Please use this product within 100 % of the rated output to prevent damage or trouble.
- This product should be used on only the indicated rated input voltage.
- The capacity of the voltage and current is depending on the type of the wiring cable so this product should be connected in an appropriate connectable wire.
- The ground terminal must be installed on to prevent electric shock or electromagnetic wave.
- Foreign materials can be damage or malfunction in case of entering into the product.
- Blowing fuse in inside of the product can cause chain damage or malfunction to the other parts. Thus, repair should be required promptly.
- This product has a certain level of leakage current. So it should be used with extreme caution when using multiple units in parallel because the sum of the leakage current is larger value.
- Please be cautious in high voltage in inside of the product to prevent electrical shock.
- Please do not use it at the following locations for the safety and reliability of the product.
 - Easy to reach to water and fire place
 - High ambient temperature and non-ventilated place
 - Lots of debris materials and dust place
 - Volatile and flammable substances place
 - High humid place
 - lots of vibration and shock place

Suffix code

Model	Code	Description
DPS-	<input type="checkbox"/> <input type="checkbox"/> <input type="checkbox"/>	DPS Power supply (DIN Rail Type)
Power output	15	15W, 30W, 50W, 75W, 100W, 120W, 180W 240W
Number of output voltage	S	1 output
Output voltage	05	5 V DC (DPS-75S, DPS-100S, DPS-120S, DPS-180S, DPS-240S are excluded)
	12	12 V DC (DPS-180S are excluded)
	15	15 V DC (DPS-75S, DPS-100S, DPS-120S, DPS-180S, DPS-240S are excluded)
	24	24 V DC
	48	48 V DC (DPS-15S, DPS-30S, DPS-50S are excluded)

Function

Rated input voltage

Input voltage	Frequency	Model
100 - 240 V AC (Free voltage)	50 - 60 Hz	DPS-15S, DPS-30S, DPS-50S, DPS-75S, DPS-100S
100 - 120 / 200 - 240 V AC (Auto-select input)	50 - 60 Hz	DPS-120S, DPS-180S, DPS-240S

※ Auto-select input?

Automatically input voltage selected regardless of input voltage 100 - 120 V AC or 200 - 240 V AC.(Dual use)

Adjustable Output voltage

Output voltage can be adjustable by adjustable resistance inside of the product.
(more than ± 5 % of rated output voltage)

Limited Inrush Current

This product has inrush current limit circuit but it should be considered carefully when selection of the external switch or fuse.

Short-Circuit Protection

When the output terminals shorted, the output is blocked. After eliminating the reason of short, voltage is output automatically.

Over-Voltage Protection

When the output voltage is reached at 115 to 140 % of the rated voltage. Blocking the current flow to protect the outside of the connected equipment and system.

Over-Current Protection

When the output current exceeds the rated capacity, activate this protection to stop output. After eliminating the reason of over-current, the output voltage is restored automatically.

Over-Temperature Protection

When PWM controller junction temperature reaches to 135 ~ 140 °C, this protection automatically stops switching to prevent components damage due to overheating.

Ripple Noise

Wiring should be shortened to reduce induction noise. Please use after reducing ripples noise sufficiently.

Product Wiring

Name of Terminal	Description
Input Terminal	AC(L)
	AC(N)
Output terminal	+V OUT
	-V OUT
	COM
	NC
	NO
	AC Output Terminal
	Protective Earth Terminal
	DC Output Terminal
	Relay Output Terminal (250 V AC, 1A, 30 V DC, 1A) ON : more than 85 % of the rated output voltage lights on OFF : Less than 85 % of the rated output voltage turns off

Please check carefully how to connect depending on model.
(different connection depending on models)

Derating curve

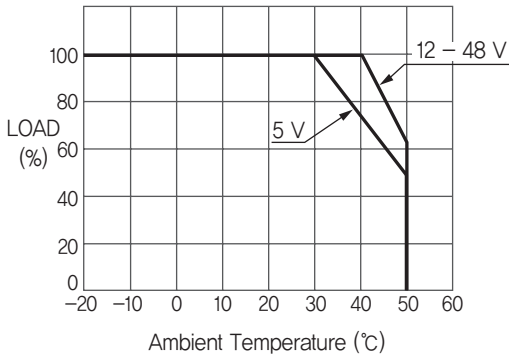
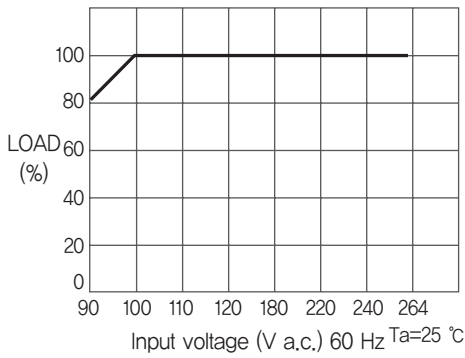

Installation instructions and precautions

- Do not force the product after installation. (Max 20 N)
- Please strip wire cover 6 ~ 7 mm when wiring.
- standard of wire

Model	Multiple wire	Single wire
DPS-15S		
DPS-30S	AWG 22 ~ 12 (0.33 ~ 3.3 mm ²)	AWG 22 ~ 12 (0.33 ~ 3.3 mm ²)
DPS-50S		
DPS-75S		
DPS-100S	AWG 30 ~ 12 (0.05 ~ 3.3 mm ²)	AWG 30 ~ 12 (0.05 ~ 3.3 mm ²)
DPS-120S		
DPS-180S		
DPS-240S	AWG 24 ~ 10 (0.2 ~ 5.26 mm ²)	AWG 24 ~ 10 (0.2 ~ 5.26 mm ²)

- In order to improve long-term reliability, the product should be install vertically and make more enough space as 50 mm vertically and 20 mm horizontally. Airfan is recommended to flow air circulation.

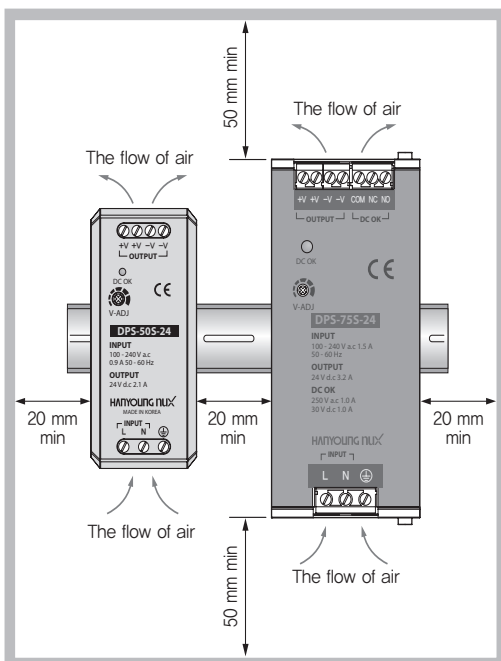

Dimensions

■ DPS-15S

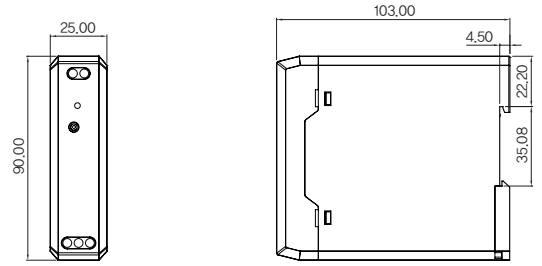

■ DPS-30S / DPS-50S

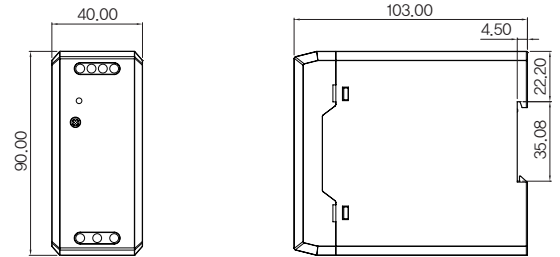

■ DPS-75S / DPS-100S

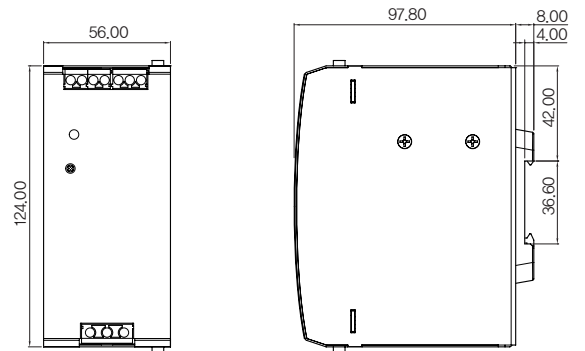

■ DPS-120S / DPS-180S

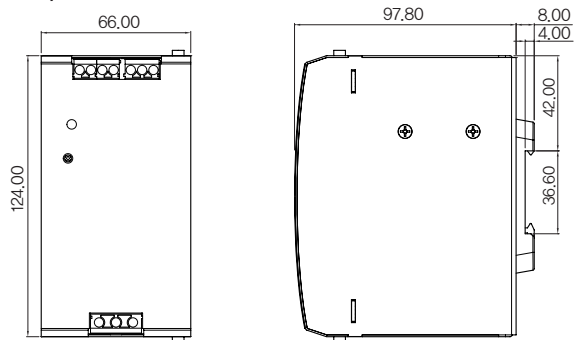

■ DPS-240S

